

GRUNDIG
made for you

COLOR TELEVISION

VISION 6 26-6840 T

VISION 6 32-6840 T

de

en

fr

it

CONTENTS

4

6

6

6

6

7

7

8

9

9

10

11

13

13

14

16

17

20

20

21

22

22

23

24

24

24

24

26

26

27

29

31

31

32

33

34

34

35

SET-UP AND SAFETY

GENERAL INFORMATION

Special features of your television

Receiving digital stations

What is Common Interface?

CONNECTION/PREPARATION

Connecting the antenna and the mains cable

Inserting batteries in the remote control

OVERVIEW

Connections on the television

Controls on the television

The remote control

SETTINGS

Searching for television stations

Changing stored channels for digital stations

Picture settings

Audio settings

TELEVISION OPERATION

Basic functions

Zoom function

Zap function

Electronic TV guide

Changing the picture format

TELETEXT MODE

TOP text or FLOF text mode

Normal text mode

Additional functions

CONVENIENCE FUNCTIONS

Convenience functions

Parental control

Timer functions

USB-MODE

The file formats

Connecting external data media

The file browser

Settings in the USB setup menu

Playback - Basic functions

Additional playback functions

CONTENTS

37

37

37

37

39

40

41

41

42

42

42

42

43

43

43

44

44

45

47

49

49

49

50

50

50

51

52

USING EXTERNAL DEVICES

DVD player, DVD recorder, video recorder or set-top box

High definition - HD ready

Connecting a DVD player, DVD recorder, video recorder or set-top box

Headphones

Decoder or satellite receiver

Camcorder

Hi-fi system/AV receiver

PC MONITOR MODE

Connecting a PC

Selecting the channel position for the PC

Settings for the PC

OPERATION WITH COMMON INTERFACE

Inserting the CA module

Access control for CA module and smart card

SPECIAL SETTINGS

Tuning digital television stations

Tuning analogue television stations

Changing stored channels for analogue stations

INFORMATION

Displaying signal information

Updating software

Technical data

Service information for dealers

Environmental note

Troubleshooting

Additional Information for units sold in the UK.

SET-UP AND SAFETY

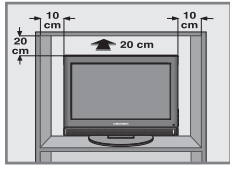

Please note the following information when setting up your television set.

This television set is designed to receive and display video and audio signals.

Any other use is expressly prohibited.

External light falling on the screen impairs picture quality.

To assure sufficient ventilation make sure there is enough space around it in the wall unit.

The television set is designed for use in dry rooms. If you do use it in the open, please ensure that it is protected from moisture, such as rain or splashing water. Do not expose the television set to any moisture.

Do not place any vessels such as vases on the television, as they may spill liquid, thus presenting a safety risk.

Place the television set on a solid, level surface. Do not place any objects such as newspapers on the television set or cloth or similar items beneath it.

Do not place the television set close to heating units or in direct sunlight, as this will impair cooling.

Heat build-up can be dangerous and shortens the operating life of the television set. For reasons of safety, have a specialist remove any dirt deposits in the set from time to time.

Do not open the television set under any circumstances. Warranty claims are excluded for damage resulting from improper handling.

Make sure the power cord or the power supply unit (if provided) are not damaged.

The television set may only be operated with the mains cable/adapter supplied.

Thunderstorms are a danger to all electrical devices. Even if the television set is switched off, it can be damaged by a lightning strike to the mains or the antenna cable. Always disconnect the mains and antenna plugs during a storm.

Clean the screen with a soft, damp cloth. Only use plain water.

Please note when deciding where to put the device that furniture surfaces are covered by various types of lacquer and plastic, most of which contain chemical additives. These may cause corrosion to the feet of the device, thus resulting in stains on the surface of the furniture which can be difficult or impossible to remove.

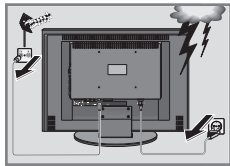
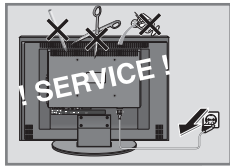
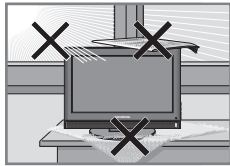
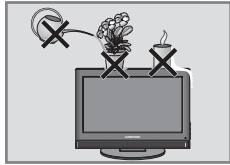

SET-UP AND SAFETY

The screen of your LCD television meets the highest quality standards and has been checked for pixel faults.

Despite the great care taken in manufacturing, technological reasons make it impossible to completely discount the possibility that some pixels may be faulty.

Provided they are within the thresholds specified by the DIN norm, pixel faults of this kind cannot be regarded as a defect as defined by the warranty.

Notes:

Do not connect any other equipment while the device is switched on. Switch off the other equipment as well before connecting it. Only plug the device into the mains socket after you have connected the external devices and the antenna. Make sure the power plug is freely accessible.

Caution:

If you want to use a wall bracket for your television, make sure you read the assembly instructions for the wall bracket carefully or have your specialist dealer mount it for you.

When buying the wall bracket, make sure that all the fastening points needed on the television are there on the wall bracket and that they are all used when it is mounted.

GENERAL INFORMATION



Special features of your television

Your television set enables you to receive and watch digital stations (via DVB-T), including in High Definition (HD). At present, reception for these digital television stations in High Definition is only possible in some countries in Europe.

This television can receive and process all analogue and all unencrypted digital stations. This television set has an integrated digital and analogue receiver. The digital receiver unit converts the signals from digital stations to provide outstanding audio and picture quality.

The TV guide (only for digital stations) tells you of any schedule changes at short notice, and provides an overview of all the stations' schedules for the next few days.

Detailed information on the individual stations – if it is provided by the broadcaster – is also available in the electronic programme guide.

You can connect various data media, for example, an external hard drive, a USB memory stick or a digital camera to the USB socket. Using the file browser, you can then select and play the file formats you want (for example, MP4, MP3 or JPEG data).

Receiving digital stations

To receive digital stations you need a digital rooftop or indoor antenna (passive or active indoor antenna with its own power supply).

Unlike analogue broadcasting, not every station has its own transmission frequency. Instead, several stations are grouped into what are known as bouquets on a regional or national level.

You can find the current transmission information on teletext from various broadcasters, or look in a TV guide or on the Internet.

What is Common Interface?

Common Interface (CI) is an interface for DVB receivers.

Encoded stations can only be viewed with a CA module suitable for the encoding system and the corresponding smart card.

The television set is equipped with a Common Interface slot into which CA modules from various providers can be inserted.

You can insert the provider's smart card into the CA module in order to enable the encrypted stations you want to see.

CONNECTION/PREPARATION

Connecting the antenna and the mains cable

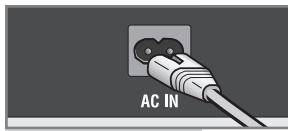
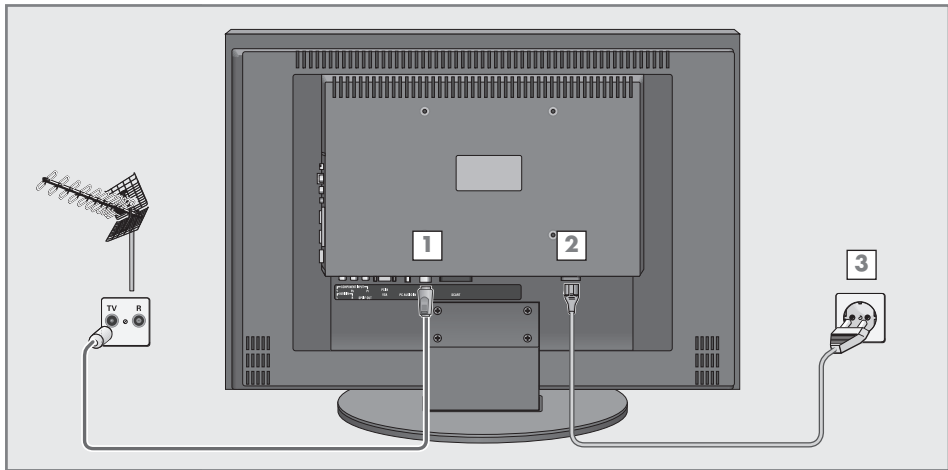

- 1 Plug the cable of the rooftop or indoor antenna (passive or active indoor antenna with its own power supply for digital television stations) into the antenna socket »**ANT IN**« on the television set;

or

plug the rooftop antenna cable (for analogue television stations) into the »**ANT IN**« socket on the television.

Note:

When connecting an indoor antenna you may have to try it out at different positions until you get the best reception.

- 2 Plug the mains cable supplied into the »**AC IN**« mains socket of the television.
- 3 Plug the mains cable into the wall socket.

Note:

Only plug the device into the mains socket after you have connected the external devices and the antenna.

Only connect the television using the power cord supplied to a suitable earthed safety socket.

Do not use an adapter plug or extension lead which does not meet the applicable safety standards. Do not tamper with the power cord.

CONNECTION/PREPARATION _____

Inserting batteries in the remote control

- 1 Open the battery compartment by removing the lid.
- 2 Insert the batteries (3 x 1.5 V micro for example R03 or AAA). Observe the polarity (marked on the base of the battery compartment).
- 3 Close the battery compartment.

Note:

If the television no longer reacts properly to remote control commands, the batteries may be flat. Be sure to remove used batteries.

The manufacturer accepts no liability for damage resulting from used batteries.

Environmental note

Batteries, including those which contain no heavy metal, may not be disposed of with household waste. Please dispose of used batteries in an environmentally sound manner. Find out about the legal regulations which apply in your area.

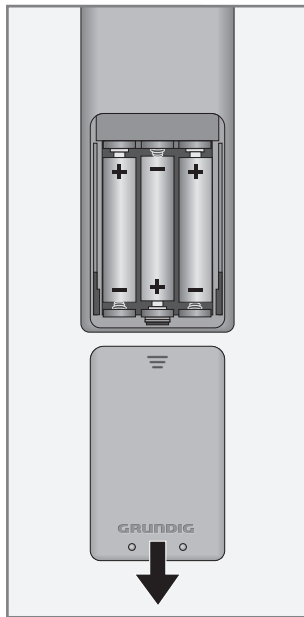

OVERVIEW

Connections on the television

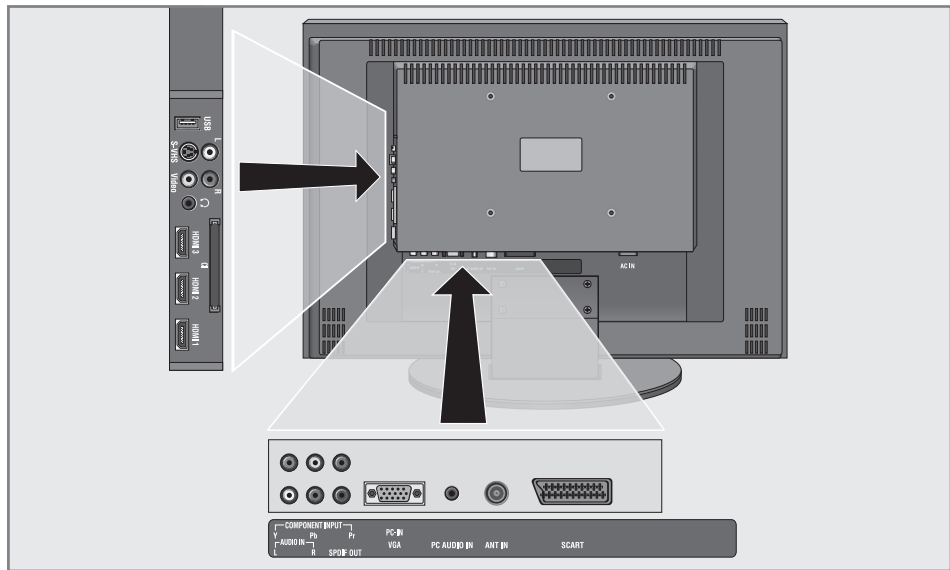

USB

USB socket for external data media.

L R

Audio signal input for camcorder.

S-VHS

Video signal input for S-Video camcorder.

Video

Video signal input for camcorder.



Headphone connection (3.5 mm jack plug).

CI

Common Interface slot.

HDMI3

HDMI socket, audio/video signal input (HDMI).

HDMI2

HDMI socket, audio/video signal input (HDMI).

HDMI1

HDMI socket, audio/video signal input (HDMI).

COMPONENT INPUT

Y Pb Pr

Video signal input (YUV signal).

AUDIO IN LR

Audio signal input (YUV signal).

SPDIF OUT

Audio output sockets (coaxial) for PCM/AC3 signals. For connecting to a digital multi-channel audio/video amplifier or AV receiver.

PC-IN VGA

VGA socket, video signal input for PC.

PC AUDIO IN

Audio signal input for PC.

ANT IN

Antenna socket.

SCART

Euro/AV socket (FBAS signal, RGB signal).



AC IN

Socket for the mains cable.

OVERVIEW

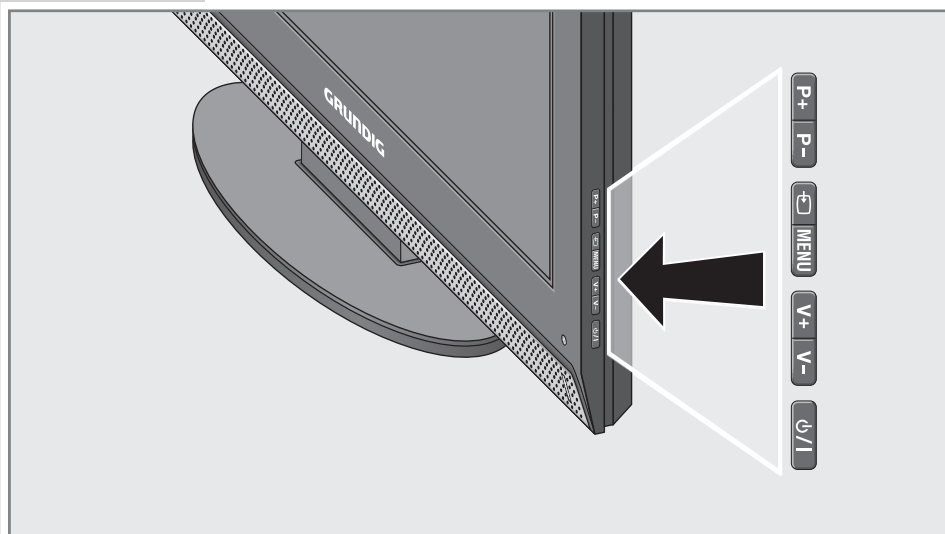
Controls on the television









- P+ P-** Switch the television on from standby.
Station selection.
Select a function in the menu.
-  Open the pre-selection for AV channels.
In the menu, press »P+« or »P-« to select and confirm
with »V+« or »V-«.
- MENU** Opens the main menu.
Select menu item with »P+« or »P-«.
Activate the function with »V+« or »V-«.
Set the function with »V+« or »V-«.
Switch off the menu with »MENU«.
- V+ V-** Adjust the volume.
Select menu functions.
-  Switches the television on and back into standby.
The only way to disconnect the television from the mains
supply is to pull the plug.

OVERVIEW



The remote control

-  Switches off the television set (stand-by).
- 1...0** Switches the television on from standby mode
Selects channels directly.
- AV** Opens the pre-selection for AV channels and the USB input.
Then select with »**V**« or »**^**«.
- ?** Displays the number and name of a station;
reveals answers in teletext mode.
- PIP** Updates the page in teletext mode.
-  Switches between picture formats.
-  Sound on/off (mute).
- i** Opens the menu.
- Z** Zapping function;
switches the menus back one menu level.
- ^ v** Switches the television on from standby;
selects stations step by step;
moves the cursor in the menus up and down.
-  **(OK)** Calls up the channel list;
activates various functions.
- +** Adjusts the volume;
moves the cursor left/right.
- TXT** Switches between teletext and TV modes
- TV-G** Opens the electronic TV guide.
-  Selects various picture settings;
selects a page in teletext mode.
-  Displays the time;
selects a page in teletext mode.
-  Freeze-frame;
selects a page in teletext mode.
- ?** Selects different sound settings (in analogue TV operation);
selects different languages (in digital TV operation);
selects desired topic in teletext mode.

OVERVIEW



SCAN

Enlarges the picture;
switches to double character size in teletext mode.

PAT

Selects the split screen function in teletext mode.

S

Selects different subtitles (in digital TV operation);
selects subpages in teletext mode.

P

Selects channel lists (»All Channels«, »RADIO«,
»FAV1« to »FAV4«);
page hold in teletext mode.

M

Switches to operation of a GRUNDIG
digital receiver, GRUNDIG digital receiver with
hard disk (PDR), GRUNDIG DVD player,
GRUNDIG DVD recorder or GRUNDIG
AV receiver.

Press »M« until the »DR«, »DVD« or »AMP«
display lights up.

Then select the one you want.

If you do not press a button within 10 seconds,
the remote control returns to television mode
(»TV«).

Note:

»DR« has been programmed for operating a
GRUNDIG digital receiver (remote control
level 1).

»DVD« has been programmed for operating a
GRUNDIG DVD player.

»AMP« has been programmed for operating a
GRUNDIG AV receiver.

The functions available depend on the model of
the device you are using.

Just try it out.

You can change this programming:

Press and hold down »M« and press three
number buttons to enter the code:

»1«, »2«, »3« for a GRUNDIG DVD player.

»4«, »5«, »6« for a GRUNDIG DVD recorder.

»1«, »4«, »7« for a GRUNDIG digital receiver
(remote control level 1).

»2«, »5«, »8« for a GRUNDIG digital receiver
(remote control level 2).

»3«, »6«, »9« for a GRUNDIG digital receiver
with a hard disc (PDR).

SETTINGS

Searching for television stations

The television has an automatic tuning function, which first searches for digital TV channels and then analogue ones.

You start the search and can then sort the television stations into your order of preference.

There are 400 presets for digital channels and 99 for analogue channels, to which you can assign TV stations from the antenna or from the cable connection (analogue channels).

- 1 Press **»⏻«, »1...0«** or **»▼«** or **»▲«** to switch on the television from standby mode.
 - The **»Installation Guide«** menu appears when the device is first switched on.
- 2 Press **»-«** or **»+«** to select the language.

Help:

If the **»Installation Guide«** menu does not appear on the screen, make the setting by following the instructions on returning the television to its factory condition on page 26.

Note

The antenna power supply may only be switched on if the antenna is actually an active indoor antenna with a signal amplifier and it is not already supplied with a voltage via a mains plug (or similar supply).

Otherwise you may cause a short circuit and irreparably damage your antenna.

- 3 Select the **»Active Antenna Power«** with **»▼«** or **»▲«**. Press **»-«** or **»+«** to switch on the antenna voltage (**»On«**).
- 4 Select **»Auto Tuning«** with **»▼«** or **»▲«** and confirm with **»●«**.
 - **»Country Selection«** is active.
- 5 Press **»-«** or **»+«** to select the country.
- 6 Select the **»Scan Type«** with **»▼«** or **»▲«**. Press **»-«** or **»+«** to select whether you want to search for only digital television stations (DTV), only analogue television stations (ATV) or both (ATV & DTV).
- 7 Select **»Time zone«** with **»▼«** or **»▲«**. Press **»-«** or **»+«** to select time zone.
- 8 Press **»●«** to start the search.

- The **»Searching...«** menu appears, and the search for TV stations begins. This may take several minutes depending on the number of television stations received.
- The search is ended when the **»Programme Table«** appears.

Note:

The search can be ended prematurely with **»i«**.

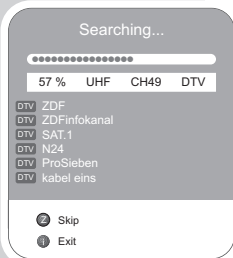
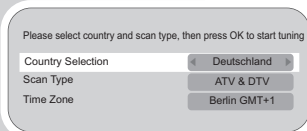
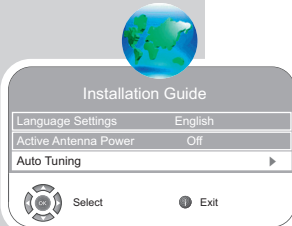
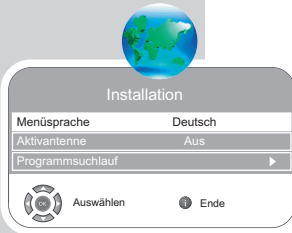

SETTINGS

Changing stored channels for digital stations

You can change the order of the channels found as required, delete channels you do not need and block access to certain presets (parental control).

Press »?« (blue) to switch between »Programme Table – ALL TYPE«, »Programme Table – DTV«, »Programme Table – RADIO« and »Programme Table – ATV«.

Press »👁« (red) to display the channels assigned to a network.

Press »P« to switch the channel list to the next page, press »S« to switch it back to the previous page.

Opening the channel list

- 1 Open the menu with »i«.
– The »PICTURE« menu is displayed.
- 2 Select the »CHANNEL SETUP« menu with »-« or »+«.
- 3 Select »Programme Table« with »▼« or »▲« and confirm with »●«.
– The »Programme Table« menu is displayed.

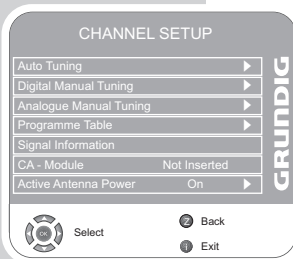

Moving channels to different presets

- 1 In the »Programme Table« menu, press »▼« or »▲« to select the channel to be moved.
- 2 Press »🕒« (green) to highlight the channel.
- 3 Enter the new presets with one, two or three digits using »1...0«.
- 4 Press »●« to confirm the entry.

Notes:

To sort the other television channels, repeat steps **1** to **4**.

Stations that are assigned to fixed preset numbers (such as French stations with LCN coding) cannot be moved.

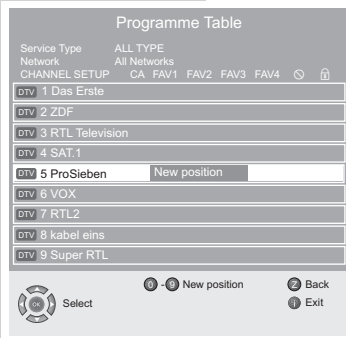

SETTINGS

Creating a list of favourites

You can select your favourite channels and save them in up to four lists (FAV1 to FAV4).

- 1 In the »Programme Table« menu, select the television channel with »▼« or »▲«.
- 2 "Push" the television channel with »-« or »+« into the favourites list 1 to 4 and save it with »●«.
 - The position in the favourites list is marked with »✓«.
 - You can enter the same channel in more than one favourites list.

Note:

You can delete channels from the favourites list. Press »▼« oder »▲« and »-« or »+« to select the channel and »●« to delete it.

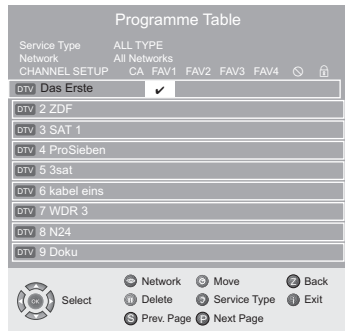

Deleting channels

- 1 In the »Programme Table« menu, press »▼« or »▲« to select the channel to be deleted and press »□□« (yellow) to confirm.
- 2 Press »⌂« (green) to confirm the deletion.

Notes:

Press »👁« (red) to delete all the channels.

Presets whose channels have been deleted are no longer shown in the »Programme Table«.

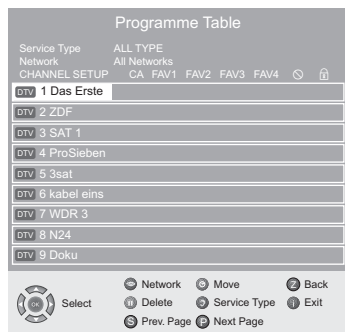

Skipping television stations

You can highlight television stations to be skipped when you select with »▼« or »▲«. It is still possible to select using the number buttons.

- 1 In the »Programme Table« menu, select the television channel with »▼« or »▲«.
- 2 Press »+« to switch to the »⊙« symbol and press »●« to highlight the television channel.
 - The channel is marked with »⊙«.

Note:

Channels can be enabled again. Press »▼« or »▲« to select the channel, press »+« to switch to the symbol »⊙« and press »●« to enable the channel again.

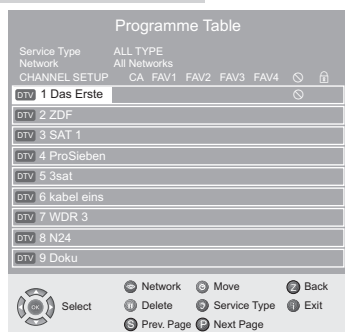

Ending the settings

- 1 Press »i« to finish the settings.

SETTINGS

Audio settings

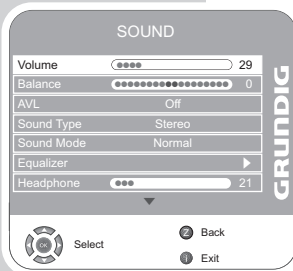

- 1 Open the menu with »i«.
- The »PICTURE« menu is displayed.
- 2 Select the »SOUND« menu with »-« or »+« and confirm with »●«.

Note:

Additional operations are explained in the following sections.

Volume

- 1 Select »Volume« with »V« or »^« and adjust the setting with »-« or »+«.

Balance

- 1 Select »Balance« with »V« or »^« and adjust the setting with »-« or »+«.

Automatic volume

The television channels broadcast at different volumes. The automatic volume limiting (AVL) function means the volume is kept the same when you switch between channels.

- 1 Select »AVL« with »V« or »^« and then select »On« with »-« or »+«.

Note:

If the »SRS« setting has been selected in the »Sound Mode« line, the AVL line cannot be selected.

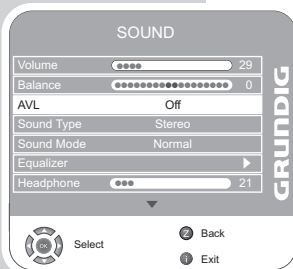

Stereo / two channel, mono

If the device receives two channel programmes, e.g. a film with the original sound on sound channel B (display: »Dual II«) and the dubbed version on sound channel A (display: »Dual I«), you can select the sound channel you desire.

If the device receives stereo or Nicam programmes, it switches automatically to stereo sound (display: »Stereo«).

You can switch the sound to »Mono« if the stereo reception quality is poor.

- 1 Select »Sound Type« with »V« or »^« and adjust the setting with »-« or »+«.

Stereo width

Widens the audio output for stereo programmes and improves the sound with mono reception.

- 1 Select »Sound Mode« with »V« or »^«.
- 2 Press »-« or »+« to select the setting »Spatial«.

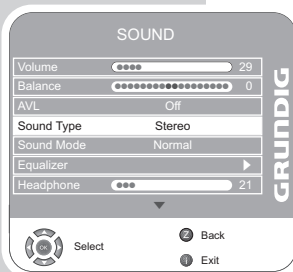

SETTINGS

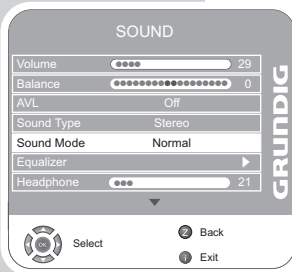

SRS TruSurround XT*

SRS TruSurround XT is a patented audio technology, which is integrated in the television set and only requires the built-in speakers to produce a Surround Sound effect.

- 1 Select the »Sound Mode« line with »▼« or »▲«.
- 2 Select the setting »SRS« with »-« or »+«.

Equaliser

The equaliser offers you four preset sound settings (Music, Sports, Movie and Speech) and one which you can create yourself (User).

- 1 Select »Equalizer« with »▼« or »▲« and confirm with »●«.
- The »EQUALIZER« menu appears.

Note:

If the »SRS« setting has been selected in the »Sound Mode« line, the »Equalizer« line cannot be selected.

- 2 Select the audio setting »User« with »-« or »+« and confirm with »▼«.
- The frequency band »120 Hz« is activated.
- 3 Set the desired value with »▼« or »▲« and select the next frequency band with »-« or »+«.
- 4 Press »Z« to save the setting.

Audio description (audio subtitles)

Audio description is an additional audio channel for people who are visually impaired. The activities, surroundings, scene changes or the appearance, the gestures and facial expressions of the actors are described.

This sound is transmitted at the same time as the normal sound with digital television stations. This depends on the programme being broadcast.

- 1 Select »▼« with »▼« or »▲«.
- 2 Select »Audio Description« with »▼« or »▲« and press »●« to confirm.
- 3 Select »On« with »-« or »+«.
- 4 Select the »Volume« with »▼« or »▲« and adjust with »-« or »+«.

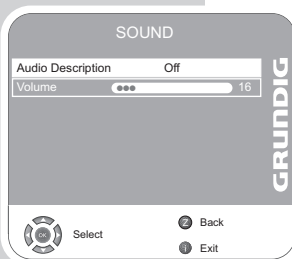
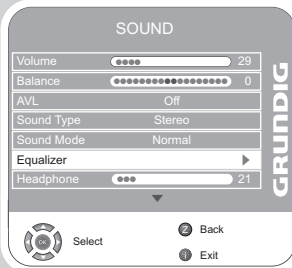

* Under licence from SRS Labs, Inc.

TruSurround XT, SRS and the  symbol are trademarks of SRS Labs, Inc.

SETTINGS

TruBass and Dialog Clarity

The »TruBass« setting gives you an increased bass effect.

»Dialog Clarity« recognises dialogue sections in audio recordings and improves dialogue reproduction.

The two functions can be found on the second page of the »SOUND« menu.

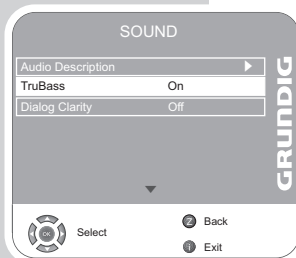

Note:

The »SRS« setting must be selected in the »Sound Mode« line.

- 1 Select »TruBass« or »Dialog Clarity« with »V« or »^«.
- 2 Select the setting with »-« or »+«.
- 3 Press »Z« to end the setting.

Concluding the settings





- 1 Press »i« to finish the settings.

TELEVISION OPERATION







Basic functions



Switching on and off







- 1 Press »**0**« or »**0**« or »**0**« to switch on the device from standby mode.
- 2 Press the »**0**« button to switch the television to standby mode.

Selecting channels





- 1 Use »**1...0**« to select channels directly.
- 2 Press »**0**« or »**0**« to move up and down channels.
- 3 Open the channel list by pressing »**0**«, select the station with »**0**« or »**0**« and press »**0**« to switch off the channel list.

Selecting stations from lists

You can select stations from various lists, (e.g. All Channels, FAV1).

- 1 Press »**0**« to call up the overview of channel lists.
- The overview is displayed.
- 2 Press »**0**« or »**0**« to select the channel list and »**0**« to confirm.
- 3 Press »**0**« or »**0**« to select the channel and »**0**« to confirm.



Selecting AV channels

- 1 Call up the »INPUT SOURCE« menu with »**0**«.
- 2 Select the desired AV channel position with »**0**« or »**0**« and press »**0**« to confirm.
- 3 Switch back to the television channel with »**1...0**«.

Switching between digital and analogue channels

- 1 Open the »INPUT SOURCE« menu by pressing »**0**«.
- 2 Press »**0**« or »**0**« to select »DTV« (digital presets) or »ATV« (analogue presets) and press »**0**« to confirm.

Adjusting the volume

- 1 Adjust the volume with »**0**« or »**0**«.

Muting

- 1 Use »**0**« to switch the sound off (mute) and to switch it on again.

Displaying time

- 1 You can display the time by pressing the »**0**« button.

TELEVISION OPERATION

Displaying information

- 1 Press »?« to display the information.
 - The display disappears automatically after a short while.

Freeze-frame

If you wish to view a particular scene for longer, you can freeze the frame of the current programme.

- 1 Press »□□« (yellow).
- 2 To quit this function, press »□□« again.

Picture settings

You can select different picture settings.

- 1 Select the desired picture setting from »User«, »Sports«, »Movie«, »Natural« or »Vivid« with »👁«.
 - You can alter the »User« picture setting, see the "Picture settings" chapter on page 16.

Sound settings

You can select various audio settings when watching analogue channels.

- 1 Select »User«, »Speech«, »Movie«, »Sports«, »Music« or by pressing »🔊« (blue).
 - You can modify the »User« audio setting - see the "Equaliser" chapter on page 18.

Audio language

You can select various languages when watching digital channels. This depends on the programme being broadcast.

- 1 Press »🔊« (blue) to open the selection menu.
- 2 Select your language using »▼« or »▲« and press »●« to confirm.

Subtitles

You can select various subtitles when watching digital channels. This depends on the programme being broadcast.

- 1 Open the selection menu with »S«.
- 2 Select your language using »▼« or »▲« and press »●« to confirm.

Zoom function

With this function, you can enlarge the picture on the television or computer.

- 1 Activate the zoom function by pressing and holding down »SCAN«.

TELEVISION OPERATION

Zap function

This function allows you to save the television channel which you are currently watching and switch to other channels (zapping).

- 1 Select the channel you want to save in the zap memory with »1...0« or »▲« »▼«, (e.g. channel 1, BBC 1) and save by pressing »Z«.
- 2 Change channels with »1...0« or »▲« »▼«.
- 3 You can now use »Z« to switch between the saved channel (in the example, BBC 1) and the channel you were watching before.
- 4 Press »i« to quit the zap function.
 - The display disappears.

Electronic TV guide

The electronic program guide offers an overview of all programmes that will be broadcast in the next week (for digital stations only).

- 1 Press »TV-G« to see programme information.

Notes:

Not all stations supply provide a detailed TV guide.

Many broadcasters supply the daily programme but no detailed descriptions.

There are broadcasters which do not provide any information at all.

- 2 Select the television station with »▼« or »▲«.
 - The programmes being shown on the selected television channel for today are displayed.
 - In addition, information about the programme currently being transmitted is displayed with detailed information.
- 3 Press »+« to switch to today's programme.

Note:

You can open and switch off extensive programme information with »?«.

- 4 Press »▼« to select information on the next programme and, »▲« to return to the information for the current programme.
- 5 Press »☺« (green) to select the next days, and »☹« (red) to return to today.
- 6 Switch back to the station selection by pressing »=«.

Note:

Press »?« (blue) and »●« to transfer the selected programme into the memory timer.

- 7 Press »i« to quit the electronic programme guide.

Changing the picture format

The television automatically switches to the 16:9 format if this format is detected via the Euro-AV socket.

1 Select the picture format with . The selected picture format, for example »16:9«, appears on the screen.

- You can choose between the following picture formats:

»AUTOMATIC« format

The picture format is automatically switched to »16:9« for 16:9 programmes.

The picture format is automatically switched to »4:3« for 4:3 programmes.

»16:9« and »14:9« formats

During programmes in 4:3 format, the picture is stretched horizontally if »16:9« or »14:9« is selected.

The picture geometry is stretched horizontally.

With actual 16:9 signal sources (from a set-top box on the Euro-AV socket) the picture fills the screen completely and with the correct geometry.

»4:3« format

The picture is shown in 4:3 format.

»LetterBox« format

The letterbox setting is especially suitable for programmes in 16:9 format.

The black borders which are usually at the top and bottom of the screen are eliminated, 4:3 pictures fill the screen.

The transmitted pictures are enlarged, but are slightly cropped at the top and bottom. The picture geometry remains unchanged.

»Subtitle« format

If you cannot read the subtitles which appear on the bottom of the screen, then select »Subtitle«.

»Panorama« format

This setting is suited to films with a large width/height ratio.

During programmes in 4:3 format the picture is stretched horizontally if the »Panorama« function is selected. The picture geometry is stretched horizontally.

TELETEXT MODE

TOP text or FLOF text mode

- 1 Press »**TEXT**« to switch to teletext mode.
- 2 You can directly select teletext pages with »**1...0**«. To return to page 100, press »**i**«.

Note:

At the bottom of the screen, you will see an information line consisting of a red, green and, depending on the station, yellow and blue text field. Your remote control has buttons with the corresponding colours.

- 3 Press »**⏪**« (red) to scroll back a page.
- 4 Press »**⏩**« (green) to scroll to the next page.
- 5 Press »**⏮**« (yellow) to select chapters.
- 6 Press »**⏭**« (blue) to select topics.
- 7 Press »**TEXT**« to switch off teletext mode.

Normal text mode

- 1 Press »**TEXT**« to switch to teletext mode.
- 2 You can directly select teletext pages with »**1...0**«. To return to page 100, press »**i**«.
- 3 Press »**⏪**« to scroll back a page.
- 4 Press »**⏩**« to scroll to the next page.
- 5 Press »**TEXT**« to switch off teletext mode.

Additional functions

Skipping the waiting time

While a page is being searched for, you can switch to the television channel.

- 1 Enter the teletext page number using »**1...0**« and then press »**PIP**«.
– As soon as the page is found, the page number is displayed.
- 2 Press »**PIP**« to switch to the teletext page.

Increasing character size

If you have difficulty reading the text on the screen, you can double the character size.

- 1 To enlarge the character size of a teletext page, press »**SCAN**« repeatedly.



TELETEXT MODE



Page stop

A multiple page may contain several sub-pages, which are automatically scrolled by the transmitting station.

- 1 Stop the sub-pages with »P«.
- 2 Press »P« to quit the function.

Calling up a sub-page directly

If the selected teletext page contains further pages, the number of the current sub-page as well as the total number of pages is displayed.

- 1 Call up the sub-pages with »S«.
- 2 Press »1...0« to enter the sub-menu.
- 3 Press »S« to quit the function.

Reveal answer

Certain teletext pages contain "hidden answers" or information which can be called up.

- 1 Display information with »?«.
- 2 Conceal information with »?«.

Split screen (Split Screen)

With this function you can see the television channel on the left and the teletext page on the right.

- 1 To activate the split screen function, press »PAT«.
 - The television channel and the teletext page appear next to each other on the screen.
- 2 To deactivate the split screen function, press »PAT«.

CONVENIENCE FUNCTIONS

Convenience functions

- 1 Open the menu with »i«. - The »PICTURE« menu is displayed.

- 2 Select »OPTIONS« with »-« or »+« and press »●« to confirm.

Note:

Additional operations are explained in the following sections.

Changing the menu language

- 1 Select »Language Settings« with »▼« oder »▲« and press »●« to confirm.
- 2 Select »Language Settings« with »▼« oder »▲«.
- 3 Select the language with »-« or »+«.
- 4 Press »i« to finish the setting.

Language settings

(only for digital television channels)

You can alter the appearance of subtitles or disable them, select the subtitle language, select a second subtitle language, and select the audio language and a second audio language.

- 1 Select »Language Settings« with »▼« or »▲« and press »●« to confirm.
- 2 Select »Audio Languages«, »Subtitle Languages«, »Hard of Hearing« with »▼« or »▲« and press »●« to confirm.
- 3 Select »Primary« or »Secondary« with »▼« or »▲« and press »●« to confirm.
- 4 Press »-« or »+« to make the setting.
- 5 Select »Close« with »▼« or »▲« and press »●« to confirm.
- 6 Press »i« to end the setting.

Resetting the television to its original state

This function enables you to delete the station lists and all custom settings.

- 1 Select »Restore Factory Defaults« with »▼« oder »▲« and press »●« to confirm.
- 2 Select the »Yes « button with »-« or »+« and confirm the reset function with »●«.
- The »Installation Guide« menu is displayed.
- 3 Continue the settings as described in the chapter on searching for television stations on page 13.

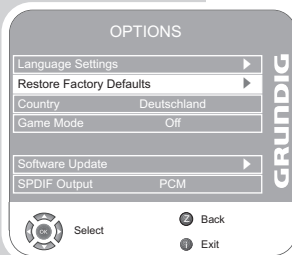
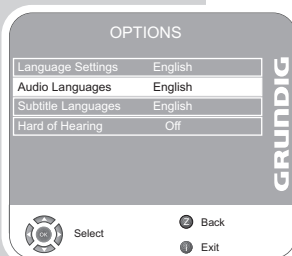
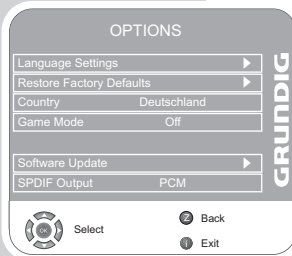

CONVENIENCE FUNCTIONS

Game mode

This function is only available for preset channels »HDMI1«, »HDMI2«, »HDMI3«, »YPBPR« or »PC«.

Use this function to adjust the screen settings of the television set for games. Connect the games console using the »HDMI1«, »HDMI2«, »HDMI3«, »COMPONENT INPUT VIDEO IN Y Pb Pr« or »PC-IN VGA« sockets.

You can no longer make settings in the »PICTURE« menu.

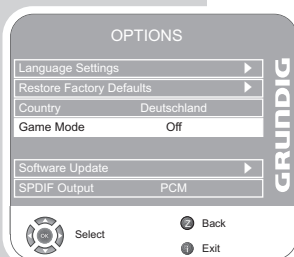

- 1 Select »Game Mode« with »▼« or »▲«
- 2 Press »-« or »+« to switch the function on or off.
- 3 Press »i« to end the setting.

Selecting the audio signal for digital output

Here you select whether the audio signal is emitted from the »SPDIF OUT« socket in PCM data format or in AC3 format.

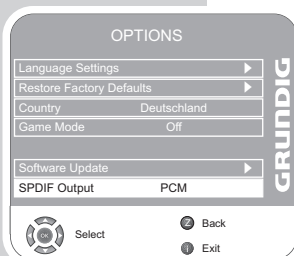

- 1 Select »SPDIF Output« by pressing »▼« or »▲«.
- 2 Select the signal type (»PCM« or »Dolby* D«) by pressing »-« or »+«.
- 3 Quit the setting by pressing »i«.

Parental control

- 1 Open the menu with »i«.
- The »PICTURE« menu is displayed.
- 2 Select the »PARENTAL CONTROL« menu with »-« or »+« and press »●« to confirm.
- 3 Enter the PIN code »0000« with »1 ... 0«.

Note:

Additional operations are explained in the following sections.

Lock the system

Using this function, you can lock the television menus so that they can only be accessed by entering a PIN code.

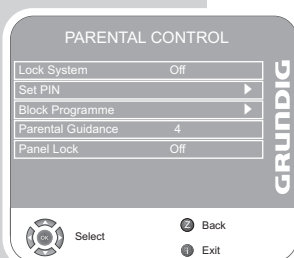

- 1 Select »Lock System« with »▼« or »▲«.
- 2 Activate the lock with »-« or »+«.
- 3 Press »i« to end the setting.

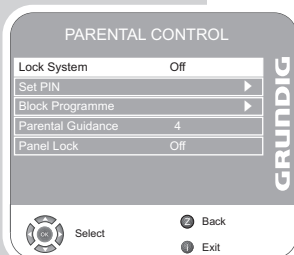

* »Dolby« and the double-D symbol are trademarks of Dolby Laboratories. Manufactured under license from Dolby Laboratories.

CONVENIENCE FUNCTIONS

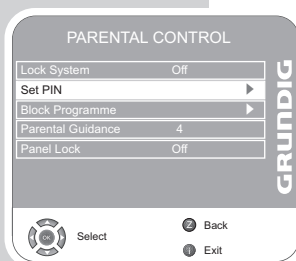

Changing the PIN code

Instead of the default code »0000«, you can enter a personal code.

Please take note of your personal code.

- 1 Select »Set PIN« with »▼« or »▲« and press »●« to confirm.
- 2 Enter your new personal PIN code with »1 ... 0« in four digits.
- 3 Enter your personal PIN code again with »1 ... 0« and press »●« to confirm.
- 4 Press »i« to end the setting.

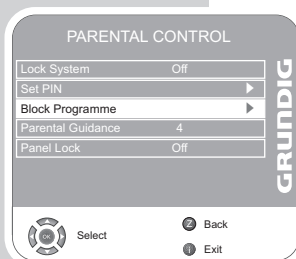

Block a television channel

You can block individual television channels which are not suitable for children using a personal PIN code.

- 1 Select »Block Programme« with »▼« or »▲« and press »●« to confirm.
- The channel list is displayed.
- 2 Select the television channel in the »Programme Table« with »▼« or »▲« and press »⏻« (green) to confirm.
- The »⏻« symbol is displayed in front of the channel in the Programme Table.
- 3 Press »i« to end the setting.

Note:

Press »▼« or »▲« to release the channel and switch off the block by pressing »⏻« (green).

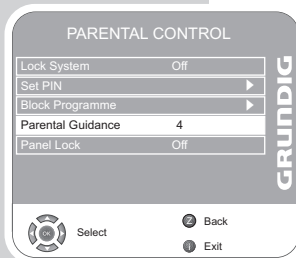

Authorise channels

There are movies which contain contents or scenes which are not suitable for children.

Certain programmes contain information which identifies these contents or scenes and have been given an access level from 4 to 18. You can select one of the access levels and thus authorise the playback.

- 1 Select »Parental Guidance« with »▼« or »▲«.
- 2 Select the access level with »-« or »+«.
- 3 Press »i« to end the setting.

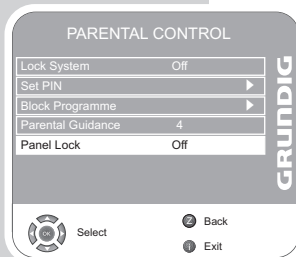

Blocking the control panel (parental control)

If the control panel block is activated, the buttons on the television do not work.

- 1 Select »Panel Lock« with »▼« or »▲«.
- 2 Activate (On) or deactivate (Off) the panel block with »-« or »+«.
- 3 Press »i« to end the setting.

CONVENIENCE FUNCTIONS

Timer functions



- 1 Open the menu with »i«.
 - The »PICTURE« menu is displayed.
- 2 Select the »TIMER« menu with »-« or »+« and press »●« to confirm.

Notes:

The correct time is shown in »Clock«.

Additional operations are explained in the following sections.

Switch-off timer

In the »Off Time« menu, you can enter a switch-off time for the television. The television switches off after the entered time has elapsed in stand-by.



- 1 Select »Off Time« with »▼« or »▲« and press »●« to confirm.
- 2 Select »Repeat« with »▼« or »▲« and select the mode with »-« or »+«.
- 3 Select »Hour« with »▼« or »▲« and enter the time with »1...0«.
- 4 Select »Minute« with »▼« or »▲« and enter the time with »1...0«.
- 5 Select »Close« with »▼« or »▲« and press »●« to confirm.
- 6 Press »i« to end the setting.

Switch-on timer

In the »On Time« menu, you can enter a switch-on time for the television.

The television switches on with the preset volume and the desired channel after the set time in stand-by mode has elapsed.



- 1 Select »On Time« with »▼« or »▲« and press »●« to confirm.
- 2 Select »Activate« with »▼« or »▲« and press »-« or »+« to choose when the television should switch on.
- 3 Select »Hour« with »▼« or »▲« and enter the time with »1...0«.
- 4 Select »Minute« with »▼« or »▲« and enter the time with »1...0«.
- 5 Select »Volume« with »▼« or »▲« and set the volume by pressing »-« or »+«.
- 6 Select »Mode« with »▼« or »▲« and press »-« or »+« to select »DTV« or »ATV«. This entry is only possible if you have already entered a switch-on time.
- 7 Select »Program« with »▼« or »▲« and enter the television channel by pressing »-« or »+«.
- 8 Select »Close« with »▼« or »▲« and press »●« to confirm.
- 9 Press »i« to end the setting.

CONVENIENCE FUNCTIONS

Enter the switch-off time (Sleep Timer)

In the »Sleep Timer« menu you can enter a time for the television to switch off. After this time has elapsed, the television switches to standby mode.

- 1 Select »Sleep Timer« with »▼« or »▲«.
- 2 Select the switch-off time with »-« or »+«.

Note:

Switch off the function by pressing »-« or »+« to set it to »Off«.

- 3 Press »i« to end the setting.



Automatic switch-off (Auto Timer)

If this function is activated, the television switches off after 5 minutes on stand-by if no video signal is transmitted.

- 1 Select »Auto Sleep« with »▼« or »▲«.
- 2 Press »-« or »+« to switch the function »On«.

Note:

Switch off the function by pressing »-« or »+« to set it to »Off«.

- 3 Press »i« to end the setting.



Setting the time zone

The television automatically detects the local difference to Greenwich Mean Time (the selected channel provides a time signal). You can set the local time difference yourself if the time is not detected or is not the same as your local time.

- 1 Select »Time Zone« with »▼« or »▲«
- 2 Set the time zone with »-« or »+« (in Germany: + 1.00 hour).
- 3 Press »i« to end the setting.



USB-MODE

The file formats

Your television can be operated via the USB input with the following file formats:

MP4 video data

The MP4 process was designed to compress video files. An MP4 video is an encoder/decoder, based on the MPEG-4 compression system, which is used to decrypt and display compressed video data.

This enables the television to play back videos compressed in the MPEG 4 SP format.

MPEG 4 SP files are “packaged” with the audio data - which have been compressed using MP3, AAC or Dolby Digital® - in this “.AVI” or “.MP4” file.

MP3/WMA audio data

MP3 stands for MPEG-1 Audio Layer 3 and comes from the Motion Picture Expert Group (MPEG) standard, which was developed for compressing audio and video data.

WMA is a compression standard for audio data (Windows Media Audio).

These formats enable audio files to be saved on a computer with a sound quality similar to that of a CD.

MP3 files can be organised into folders and subfolders similar to files on a computer.

JPEG picture data

JPEG stands for Joint Picture Experts Group. This process was designed to compress picture files.

JPEG files can be saved onto a data medium along with other file types.

The files can be compiled in folders. This structure is similar to that of an MP3 CD.

USB-MODE

Connecting external data media

Before connecting the data medium, switch the television to stand-by with »**⏻**«. Connect the device and then switch the television on again. Before connecting the data medium, the television must first be switched to standby, otherwise files can be damaged.

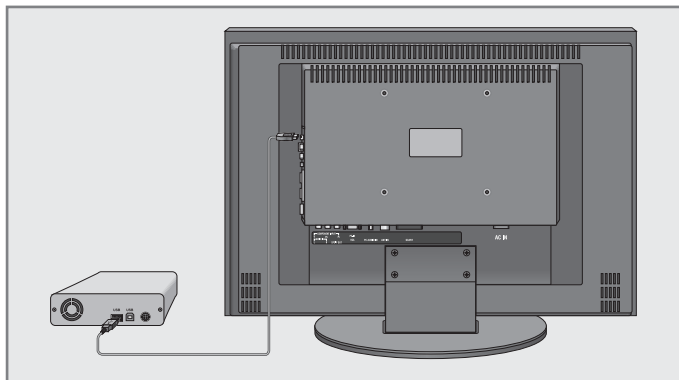

- 1 Connect the USB interface »**USB**« of the television and the corresponding socket on the data device (external hard drive, digital camera, card reader or MP3 player) using a USB cable;

or

plug the memory stick into the USB interface »**USB**« of the television.

Note:

A bi-directional data transfer as defined for ITE (Information Technology Equipment) devices in EN 55022/EN 55024 is not possible.

USB transfer is not in itself an operating mode. It is only an additional function.

USB-MODE

The file browser

The file browser displays the data (AVI., JPEG, MP3, MP4 or WMA data) that the external data medium offers.

If a data medium contains different file formats, you can deactivate data you do not need for the playback using a filter function (All Supported, Text, Movie, Music, Photo).

The main menu of the file browser

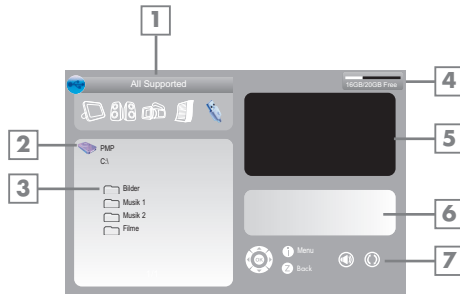

- 1 Selected data format.
- 2 Name of the data medium.
- 3 Total folders on the data medium.
- 4 Total memory and available memory of external data medium.
- 5 Inset picture of a selected JPEG picture.
- 6 Status information for the selected file.
- 7 Menu navigation.

USB-MODE

Settings in the USB setup menu

Opening the USB setup menu

- 1 Open the menu with »i«.
 - The »PICTURE« menu is displayed.
- 2 Select the »USB SETUP« menu with »-« or »+«.

Note:

Additional operations are explained in the following sections.

Switching on automatic preview

If the automatic preview is switched on, you can see the selected JPEG picture in the main menu of the file browser.

- 1 Select »Auto Preview« with »V« or »^«.
- 2 Press »-« or »+« to switch on the (on) function.
- 3 Press »i« to end the setting.

Selecting the display duration of the slideshow

- 1 Select »Slide Show Interval« with »V« or »^«.
- 2 Select the time (3, 5, 10 seconds) with »-« or »+«.
- 3 Press »i« to end the setting.

Selecting the display mode

- 1 Select »View Mode« with »V« or »^«.
- 2 Press »-« or »+« to select the function.
- 3 Press »i« to end the setting.

Playback – Basic functions

- 1 Press »AV« to select data medium, press »V« or »^« to select »USB« and press »●« to confirm.
 - The file browser (the "Contents") of the data medium is displayed.
- 2 Select file format (All Supported, Text, Movie, Music, Photo) with »-« or »+«.
- 3 Switch to the file overview with »●«.
- 4 Select the file you want with »V« or »^« and press »●« to confirm.
 - A list of sub-directories appears.

Note:

Switch back to the main folder with »Z«.

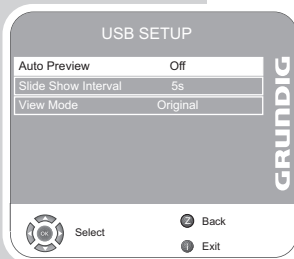

USB-MODE

- 5 Select the track or picture with »▼« or »▲« and start play by pressing »▶«.
 - You can view information on the film by pressing »👁« (red).
 - For playing MP3 or WMA data, information on the album, track and singer is displayed at the right of the menu.
 - When playing picture data, information about the resolution and the size is displayed at the right of the menu.

Note:

The file browser is switched off when playing picture data. Press »■« to switch back to the file browser.

- 6 Press »||« to pause playback.
- 7 Press »▶« to resume normal playback.
- 8 Press »■« to end playback.
 - The file browser appears.

Note:

To return to the main folder, press »▲« to select the folder icon »📁« and then press »●«.

Additional playback functions

Depending on the file formats used, the following additional functions are possible.

If the »🔒« symbol appears on the television screen, then the selected function is not possible with this file.

Play selected tracks

Only play the marked tracks.

- 1 Select the track with »▼« or »▲« and highlight using »●«.
- 2 Select the next track with »▼« or »▲« and highlight with »●«.
- 3 Start playback with »▶«.
- 4 Press »■« to end playback.

Note:

To remove the highlighting, select the track with »▼« or »▲« and switch off the marking with »●«.

Selecting a track or picture in steps (SKIP)

- 1 During playback, select the next track/picture you want with »▶|«.
- 2 Select the previous track/picture with »|◀«.
 - Playback begins with the track or picture you selected.

USING EXTERNAL DEVICES

DVD player, DVD recorder, video recorder or set-top box

Note:

Which television socket(s) you connect your external devices to depends on the sockets the external device is equipped with and the signals which are available.

Note that with many external devices the resolution of the video signal must be adapted to the input sockets on the television (check the external device's instruction manual). You can find out which values you need to set by referring to the guidelines in the section about connection options.

Note:

Do not connect any other equipment while the device is switched on. Switch off the other equipment as well before connecting it. Only plug the device into the mains socket after you have connected the external devices.

High definition – HD ready

Your television can playback high-definition television signals (HDTV).

You can connect the input sources (HDTV set-top box or High Definition DVD player) to the »HDMI« socket (digital HDTV signal).

This ensures that you can view digital HDTV programmes, even if they are copy-protected (HDCP High Bandwidth Digital Content Protection).



Connecting a DVD player, DVD recorder, video recorder or set-top box

With a digital audio/video signal

Video signal: digital video; resolution: standard 576p; HDTV 720p, 1080i.

Audio signal: digital audio (stereo, multi-channel compression, uncompressed).

Channel position »HDMI1«, »HDMI2« or »HDMI3«.

- 1 Connect the »HDMI1«, »HDMI2« or »HDMI3« socket on the television and the corresponding HDMI socket on the external device using a standard HDMI cable (digital video and audio signal).

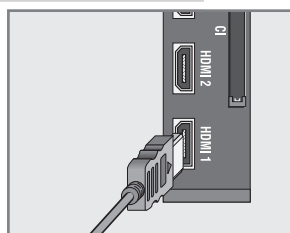

USING EXTERNAL DEVICES

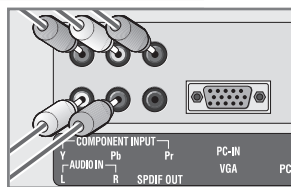

With an analogue video signal (progressive)

Video signal: YUV; resolution: standard 576p; HDTV 720p, 1080i.

Audio signal: stereo, analogue.

Channel position »YPBPR«.

- 1 Connect the »**COMPONENT INPUT Y Pb Pr**« sockets on the television and the corresponding sockets on the external device using cinch cables (video signal).
- 2 Connect the »**COMPONENT INPUT AUDIO IN L R**« sockets on the television to the corresponding sockets on the external device using cinch cables (audio signal).

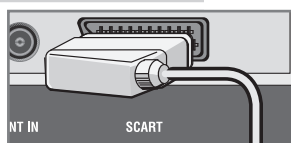
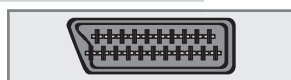

Using the Euro/AV socket

Video signal: FBAS/RGB.

Audio signal: stereo, analogue.

Channel position »SCART«.

- 1 Connect the »**SCART**« socket on the television and the corresponding socket on the external device using a EURO-AV cable (video and audio signal).

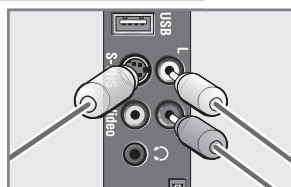

With S-Video signal

Video signal: Y/C.

Audio signal: stereo, analogue.

Channel position »S-Video«.

- 1 Connect the »**S-VHS**« socket on the television and the corresponding socket on the external device using an S-Video cable (video signal).
- 2 Connect the »**L R**« sockets on the television to the corresponding sockets on the external device using cinch cables (audio signal).

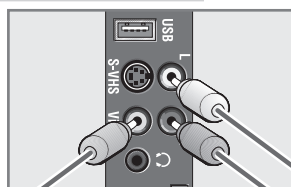

With an analog TV signal

Video signal: FBAS.

Audio signal: stereo, analogue.

Channel position »AV«.

- 1 Connect the »**Video**« cinch socket on the television and the corresponding socket on the external device using cinch cables (video signal).
- 2 Connect the »**L R**« sockets on the television to the corresponding sockets on the external device using cinch cables (audio signal).

USING EXTERNAL DEVICES

Using a video recorder, DVD player or set-top box

- 1 Switch on the video recorder, DVD player or set-top box and select the function you wish to use.
- 2 Press **»AV«**, select the input signal channel with **»▲«** or **»▼«** (**»SCART«**, **»AV«**, **»S-Video«**, **»HDMI1«**, **»HDMI2«**, **»HDMI3«** or **»YPBPR«**) and press **»●«** to confirm.

Headphones

Connecting the headphones

- 1 Plug the headphone jack (3.5 mm ø jack plug) into the headphone socket on the right side of the television.

Selecting audio settings for the headphones

- 1 Open the menu with **»i«**.
- The **»PICTURE«** menu is displayed.
- 2 Select the **»SOUND«** menu with **»-«** or **»+«** and confirm with **»●«**.
- 3 Select the **»Headphone«** with **»▼«** or **»▲«**.
- 4 Adjust the volume with **»-«** or **»+«**.
- 5 Press **»i«** to end the setting.

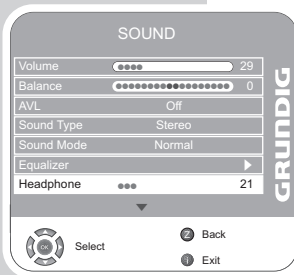
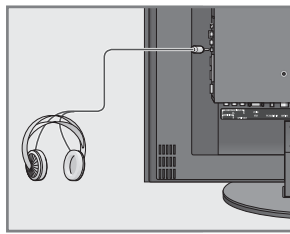

USING EXTERNAL DEVICES

Decoder or satellite receiver

In order for the television to receive encoded programs from a privately operated station, a decoder is needed.

Connecting a decoder or satellite receiver

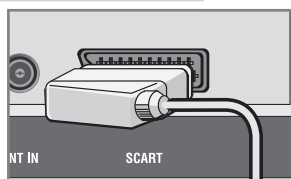
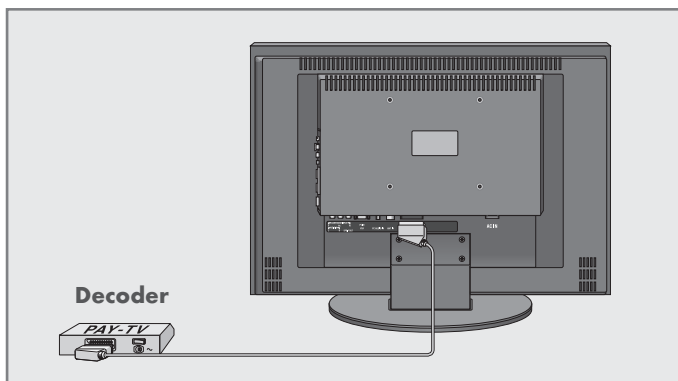

- 1 Connect the »SCART« socket on the television set and the appropriate socket on the decoder using a EURO-AV cable.

Using a decoder or satellite receiver

- 1 Switch on the television and the decoder or the satellite receiver.
- 2 Press »AV«, select the channel »SCART« with »V« or »^« and press »●« to confirm.

Activating the preset for a decoder

If this function is activated, the decoder (connected to the »SCART« socket) provides a decoded audio/video signal.

- 1 Open the menu with »i«.
- The »PICTURE« menu is displayed.
- 2 Select »OPTIONS« with »-« or »+« and press »●« to confirm.
- 3 Select the »Decoder Settings« with »V« or »^«.
- 4 Press »-« or »+« to switch the function (»On«).
- 5 Press »i« to end the setting.

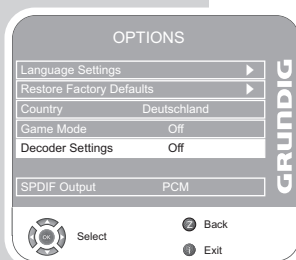

USING EXTERNAL DEVICES

Camcorder

Connecting the camcorder

- 1 Connect the yellow socket »**Video**« on the television and the corresponding socket on the camcorder (VHS, Video 8) with a cinch cable (picture signal);

or

connect the »**S-VHS**« socket (picture signal) on the television and the corresponding socket on the camcorder (S-VHS, Hi 8) with a S-Video cable.

- 2 Connect the white and red sockets »**L R**« on the television and the corresponding sockets on the camcorder with a cinch cable (audio signal).

Note:

There must not be video signals at »**Video**« and »**S-VHS**« sockets at the same time. This could lead to picture disturbances.

Operating with a camcorder

- 1 Switch on the camcorder, insert a cassette and start playback.
- 2 Press »**AV**«, select the »**AV**« or »**S-Video**« channel with »**V**« or »**▲**« and press »**●**« to confirm.

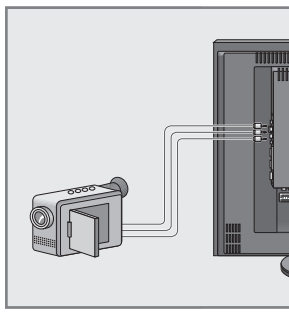

Hi-fi system/AV receiver

Connecting the hi-fi system/AV receiver

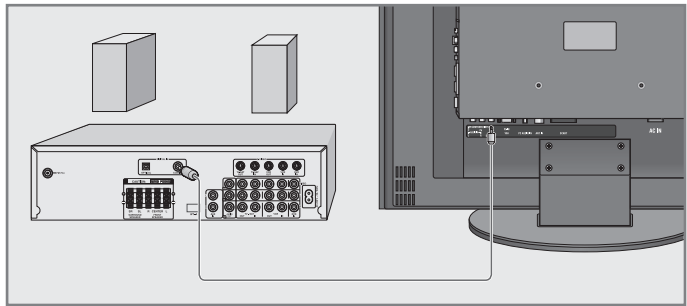

- 1 Connect the socket »**SPDIF OUT**« on the television to the corresponding socket on the AV receiver using a cinch cable (digital audio signal).

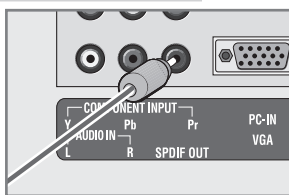

PC MONITOR MODE

Connecting a PC

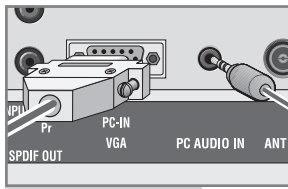
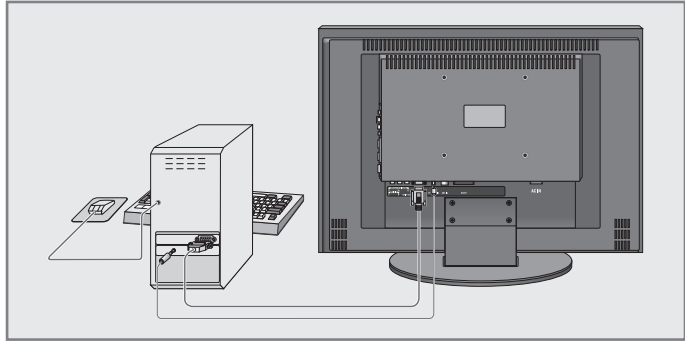

- 1 Connect the socket »**PC-IN VGA**« on the television to the corresponding socket on the PC using a VGA cable.
- 2 Connect the socket »**PC AUDIO IN**« on the television to the corresponding socket on the PC using a cinch cable (audio signal).

Note:

Adjust your PC to the monitor (for example, picture resolution 1280 x 768, picture frequency 60 Hz).

Selecting the channel position for the PC

- 1 Press »**AV**«, select the »**PC**« channel with »**V**« or »**A**« and press »**●**« to confirm.

Settings for the PC

- 1 Open the menu with »**i**«.
- The »**PICTURE**« menu is displayed.
- 2 Select the »**PC SETUP**« menu with »**-**« or »**+**« and confirm with »**●**«.
- 3 Select the function or setting you want with »**V**« or »**A**« and press »**-**« or »**+**« to execute it.

- Options:
 - »Auto Adjust«
 - »Horizontal Position«
 - »Vertical Position«
 - »Size«
 - »Phase«

For automatic PC configuration;
Adjust the picture position horizontally;
Adjust the picture position vertically;
Set the cycle frequency;
Remove horizontal flicker, blurring and horizontal lines.

- 4 Press »**i**« to finish the settings.

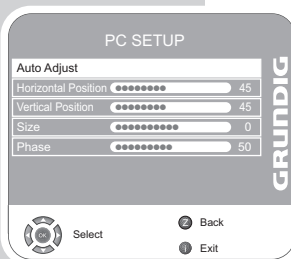

OPERATION WITH COMMON INTERFACE

Inserting the CA module

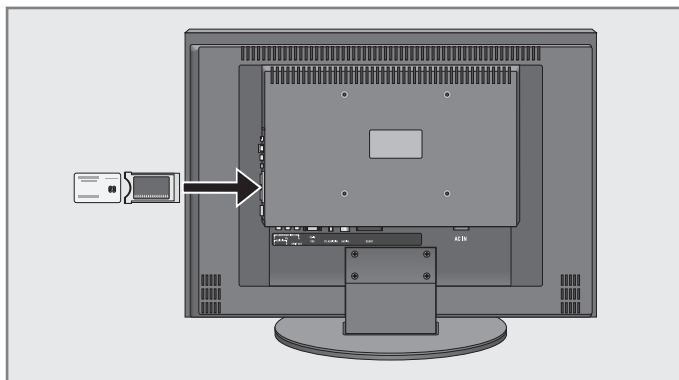

Note:

Switch off the appliance before inserting the CA module in the »CI« slot.

- 1 Insert the smart card into the CA module.
- 2 Insert the CA module with the smart card into the »CI« slot on the television.

Note:

To see which CA module is in the Common Interface slot, go to the »CA - Module« submenu.

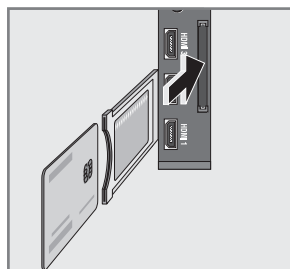

Access control for CA module and smart card

- 1 Open the menu with »i«. - The »PICTURE« menu is displayed.
- 2 Select the »CHANNEL SETUP« menu with »-« or »+« and confirm with »●«.
- 3 Select »CA-Module« with »v« or »^« and press »●« to confirm.

Notes:

This menu give operating instructions and - after you enter your PIN code - access to channels of the PAY-TV provider. The remaining settings are described in the manuals for your CA module and smart card.

- 4 Press »i« to finish the settings.

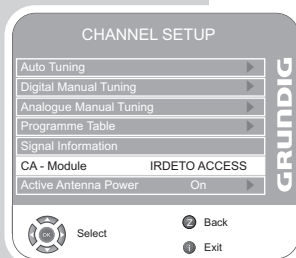

SPECIAL SETTINGS

Tuning digital television stations

This search deletes all television stations included in the channel list!

Tuning all digital television stations using the search

- 1 Open the menu with »i«.
 - The »PICTURE« menu appears.
- 2 Select the »CHANNEL SETUP« menu with »-« or »+«.
- 3 Select »Auto Tuning« with »V« or »^« and confirm with »●«.
- 4 Select »Country Selection« by pressing »V« or »^« and press »-« or »+« to make the setting.
- 5 Select the »Scan Type« with »V«.
 Press »-« or »+« to select the »DTV« display and start the search with »●«.
 - The »Searching...« menu appears, and the search for digital TV stations begins. This may take several minutes depending on the number of television stations received.
 - The search is ended when the »Programme Table« appears.

Note:

You can stop the search by pressing »i«.

- 6 Press »i« to end the setting.

Tuning the digital television stations by entering the channel numbers

- 1 Open the menu with »i«.
 - The »PICTURE« menu appears.
- 2 Select the »CHANNEL SETUP« menu with »-« or »+«.
- 3 Select »Digital Manual Tuning« with »V« or »^« and press »●« to confirm.
 - The »Digital Manual Tuning« menu appears.
- 4 Enter channel number directly with »1 ... 0« and press »●« to confirm.
 - The search is finished when the channels found appear in the list.
- 5 Press »i« to end the setting.

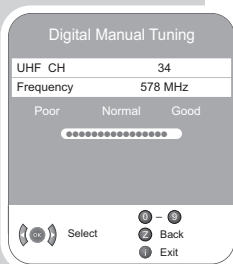
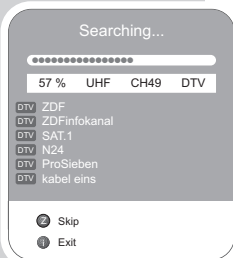
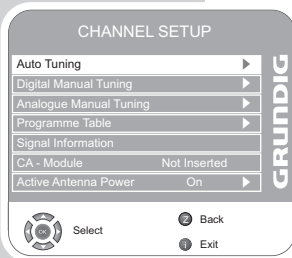

SPECIAL SETTINGS

Tuning analogue television stations

This setting is only necessary if you cannot receive any digital stations and you have not carried out an analogue search during initial setup. The television station can be set directly or using the search.

Switching the television to analogue channels

- 1 Open the »INPUT SOURCE« menu by pressing »AV«.
- 2 Select input source »ATV« with »▼« or »▲« and press »●« to confirm.

Note:

Additional operations are explained in the following sections.

Re-tuning all analogue television channels

These settings are only necessary if you can not receive any digital stations or if you want to re-tune all analogue channels.

The analogue television stations are listed in the channel list after the digital television stations.

Note:

Plug the rooftop antenna cable (for analogue television stations) into the »ANT IN« socket on the television.

- 1 Open the menu with »i«.
 - The »PICTURE« menu appears.
- 2 Select the »CHANNEL SETUP« menu with »-« or »+«.
- 3 Select »Auto Tuning« with »▼« or »▲« and confirm with »●«.
- 4 Select »Country Selection« by pressing »▼« or »▲« and press »-« or »+« to make the setting.

- 5 Select the »Scan Type« with »▼«.

Press »-« or »+« to select the »ATV« display and start the search with »●«.

 - The »Searching...« menu appears, and the search for analogue TV stations begins. This may take several minutes depending on the number of television stations received.
 - The search is ended when the »Programme Table« appears.

Note:

You can stop the search by pressing »i«.

- 6 Press »i« to end the setting.

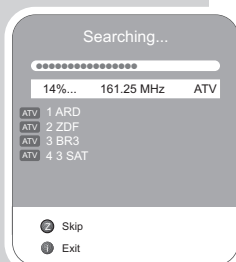
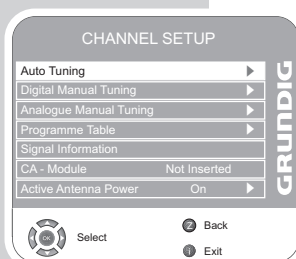

SPECIAL SETTINGS

Tuning the analogue television channels by entering the channel numbers

- 1 Open the menu with »i«.
 - The »PICTURE« menu appears.
- 2 Select the »CHANNEL SETUP« menu with »-« or »+«.
- 3 Select »Analogue Manual Tuning« with »V« or »^« and press »●« to confirm.
- 4 Select the »Programme No« by pressing »V« or »^« and press »-« or »+« to set the preset.
- 5 Select »Current Channel« with »V« or »^«.
- 6 Press »●« to choose between »S« (special channel) or »C« (channel).
- 7 Enter the channel number with »-« or »+« step by step or with »1...0« directly.

Note:

The current system is displayed in the »System« line. If the colour and/or sound is not functioning correctly, select »System« with »V« or »^«.

Select the necessary settings with »-« or »+«.

- 8 Press »<>« (red) to finish the setting.

Note:

To set other television stations, repeat steps 4 to 8.

- 9 Press »i« to end the setting.

Fine tuning analogue television stations

The television automatically tunes itself to the best possible reception. You may need to fine tune it manually in areas where the reception is poor.

- 1 Select stations with »1 ... 0« directly or step by step with »V« or »^«.
- 2 Open the menu with »i«.
 - The »PICTURE« menu appears.
- 3 Select the »CHANNEL SETUP« menu with »-« or »+«.
- 4 Select »Analogue Manual Tuning« with »V« or »^« and press »●« to confirm.
- 5 Select »Fine Tuning« with »V« or »^« and set with »-« or »+«.
- 6 Press »<>« (red) to finish the setting.
- 7 Press »i« to end the setting.

Analogue Manual Tuning

System	BG
Current Channel	S 21
Fine Tuning	◀ ▶ + 00
Search	◀ ▶
Programme No	1
Skip	Yes
Frequency	443.25 MHz



Select

- Save
- 2 Back
- 1 Exit

Analogue Manual Tuning

System	BG
Current Channel	S 21
Fine Tuning	◀ ▶ + 00
Search	◀ ▶
Programme No	1
Skip	Yes
Frequency	443.25 MHz



Select

- Save
- 2 Back
- 1 Exit

Analogue Manual Tuning

System	BG
Current Channel	S 21
Fine Tuning	◀ ▶ + 00
Search	◀ ▶
Programme No	1
Skip	Yes
Frequency	443.25 MHz



Select

- Save
- 2 Back
- 1 Exit

SPECIAL SETTINGS

Changing stored channels for analogue stations

If channels were stored with the automatic channel search during the tuning of the television channels, you can delete them. You can also store stations in a different preset, change or enter the name of a stations as well as skip channels.

Select channel lists

- 1 Open the menu with »i«.
 - The »PICTURE« menu is displayed.
- 2 Select the »CHANNEL SETUP« menu with »-« or »+« and confirm with »●«.
- 3 Select »Programme Table« with »▼« or »▲« and press »●« to confirm.

Note:

Additional operations are explained in the following sections.

Deleting channels

- 1 In the »Programme Table« menu, press »▼« or »▲« to select the channel to be deleted and press »□□« (yellow) to confirm.
- 2 Press »⊙« (green) to confirm the deletion.

Note:

Press »👁« (red) to delete all the channels.

Sorting television channels

- 1 In the »Programme Table« menu, select the channel to be moved with »▼«, »▲«, »-« or »+«.
- 2 Highlight the channel with »⊙« (green).
- 3 Select a new channel position by pressing »▲«, »▼«, »-« or »+« and then press »●« to confirm.
 - All of the channels that follow move up one position.

Note:

To sort the other television channels repeat steps 1 to 3.

Entering the channel names (maximum of 5 characters)

- 1 In the »Programme Table« menu, select the desired channel with »▲«, »▼«, »-« or »+«.
- 2 Highlight the channel with »👁« (red).
- 3 Select letters or numbers with »▲« or »▼«, move to the next position with »-« or »+« and repeat.
- 4 Store the channel name with »●«.

Note:

To enter additional channel names, repeat steps 1 to 4.

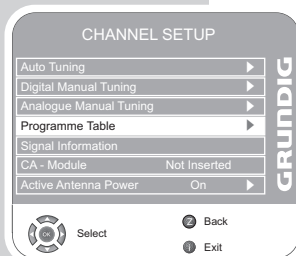

Skipping television channels

You can highlight television stations to be skipped when you select with »▲« or »▼«. It is still possible to select using the number buttons.

- 1 In the »Programme Table« menu, select the desired channel with »▲«, »▼«, »-« or »+«.
- 2 Press »+« to switch to the »⊙« symbol and press »●« to highlight the television channel.
 - The channel is marked with »⊙«.

Note:

Channels can be enabled again. Press »▼« or »▲« to select the channel, press »+« to switch to the symbol »⊙« and press »●« to enable the channel again.

Creating a list of favourites

You can select your favourite channels and save them in up to four lists (FAV1 to FAV4).

- 1 In the »Programme Table« menu, select the television channel with »▼« or »▲«.
- 2 "Push" the television channel with »-« or »+« into the favourites list 1 to 4 and save it with »●«.
 - The position in the favourites list is marked with »✓«.
 - You can enter the same channel in more than one favourites list.

Note:

You can delete channels from the favourites list. Press »▼« oder »▲« and »-« or »+« to select the channel and »●« to delete it.

Concluding the settings

- 1 Press »i« to finish the settings.

INFORMATION

Displaying signal information

(only for digital television channels)

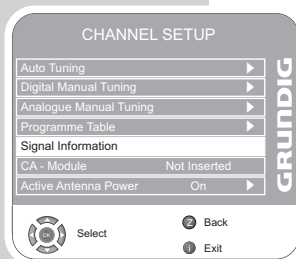

- 1 Open the menu with »i«. - The »PICTURE« menu appears.
- 2 Select the menu »CHANNEL SETUP« with »-« or »+«.
- 3 Select »Signal Information« with »V« or »^« and press »●« to confirm. - You will see information on the channel, modulation, quality and signal strength.

Notes:

The lower section of the menu shows the signal properties. The further the bar for »Quality« and »Signal Strength« extends to the right, the better the reception signal.

The signal level not only depends on your receiver system, but also on the channel which is currently active. Remember this when aligning your antenna using the signal level display.

- 4 Press »i« to end the display.

Updating software

(only for digital television channels)



- 1 Open the menu with »i«. - The »PICTURE« menu appears.
- 2 Select the »OPTIONS« menu with »-« or »+«.
- 3 Select the »Software Update« menu by pressing »V« or »^«.
- 4 Press »●« to start the software update. - The software is updated automatically, if possible.
- 5 Press »i« to end the setting.

INFORMATION

Technical data

Operating voltage:	230V, 50 Hz
Power consumption:	in operation 110 W (Vision 26) in operation 140 W (Vision 32) in standby < 1.2 W
Sound output:	2 x 14 watts music 2 x 7 sine wave (Vision 26) 2 x 20 watts music 2 x 10 sine wave (Vision 32)
Reception ranges:	Analogue: C01 ... C80, special channels S01 ... S41 Digital: VHF/UHF Bandwidth 7 MHz and 8 MHz COFDM modes: 2k and 8k Constellation: 16QAM, 64QAM, QPSK
Preset channels:	400 (digital), 99 (analogue) and 8 AV, 1 USB
Screen size:	66 cm/26" (Vision 26) 81 cm/32" (Vision 32)
Max. resolution:	WXGA 1366 x 768
Weight:	approx 9.5 kg (Vision 26) approx 11.8 kg (Vision 32)

Service information for dealers

The television set may only be operated with the mains adapter supplied.

The product complies with the following EU directives: 2006/95/EG directive for electrical equipment to be used within defined voltage ranges. 2004/108/EG directive on electromagnetic compatibility.

The device complies with the following standards: EN 60065, EN 55013, EN 55020, EN 55022, EN 55024.

Environmental note

This product has been made from high-quality parts and materials which can be re-used and recycled.

Therefore, do not throw the product away with normal household waste at the end of its life. Take it to a collection point for recycling electrical and electronic devices. This is indicated by this symbol on the product, in the operating manual and on the packaging.

Please find out about collection points operated by your local authority.

Help protect the environment by recycling used products.

Technical changes and errors reserved.

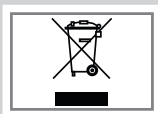

INFORMATION

Troubleshooting

If the remedies given below do not work, please consult an authorised GRUNDIG dealer. Please bear in mind that malfunctions can also be caused by external devices such as video recorders or satellite receivers.

Fault	Possible cause	Remedy
Screen lit (snow), but no station	Antenna cable	Is the antenna cable connected?
	No television station programmed	Start the station search
Poor picture contrast	Picture settings incorrectly set	Adjust the brightness, contrast or colour setting
	Problem at station	Test with another channel
Interference to picture and/or sound	Interference from other devices	Change the position of the device
Ghosts, reflection	Channel setting	Automatic or manual channel setting/fine tuning
	Antenna	Have antenna cable or system checked
No colour	Colour intensity at minimum	Turn up the colour
	TV standard setting (if setting option is available)	Select the correct colour standard
	Problem at station	Test with another channel
Picture but no sound	Volume set to minimum	Turn up or switch on the volume
Teletext missing or faulty	Problem at station	Test with another channel
	Television station (has no teletext) or antenna system	Test another channel for fine tuning and ghosts
	Station signal too weak	Check the antenna system
Remote control does not work	No optical connection	Point the remote control at the television set
	Remote control batteries	Check the batteries, change if necessary
	Operating condition undefined	Switch off the television with the main power button for approximately 2 minutes
Picture is dark in PC mode	Incorrect setting for picture resolution and picture frequency on the PC	Change the setting on the PC (for example, picture resolution 1280 x 768, picture frequency 60Hz)

NOTE:

This is a Class A product. During operation the device can cause radio interference. In this case the user may have to remedy this. Please contact your specialist dealer.

INFORMATION

Additional Information for units sold in the UK.

Units sold in the UK are suitable for operation from a 240V ac, 50Hz mains supply.

The range of multi-system receivers is built to work in most European countries. However, the mains plug and socket system for the UK differs from many European countries.

This appliance has been supplied with a fitted, non-removable, approved converter plug for use in the UK. This converter plug is fitted with a 5A rated fuse.

In case this appliance is supplied with a moulded 2-pin Euro plug only, which is unsuitable for UK operation, this must be cut off and immediately disposed of. An approved 13A, 3-pin UK plug should then be fitted by a qualified electrician.

Note:

The severed Euro plug must be destroyed to avoid a possible shock hazard should it be inserted into a socket elsewhere.

If a non-rewireable 3-pin plug or a rewireable 13A (BS1363) 3-pin plug is used, it must be fitted with a 5A ASTA or BSI approved BS1362 fuse. If any other type of plug is used it must be protected by a 5A fuse either in the plug, or at the distribution board. If this type of plug becomes defective, ensure that the fuse is removed before disposal, to eliminate potential shock hazard.

If it is necessary to change the fuse in the non-rewireable plug, the correct type and rating (5A ASTA or BSI approved BS1362) must be used and the fuse cover must be refitted. If the fuse cover is lost or damaged, the lead and plug must not be used until a replacement is obtained. Replacement fuse covers should be obtained from your dealer.

Important:

The wires in the mains lead are colour coded in accordance with the following code:

BLUE - NEUTRAL

BROWN - LIVE

As the colours of the wires in the mains lead of your appliance may not correspond with the coloured marking identifying terminals in your plug, proceed as follows:

Connect the BLUE coloured wire to plug terminal marked with the letter "N" or coloured black.

Connect the BROWN coloured wire to the plug terminal marked with the letter "L" or coloured red.

In no circumstance must any of the wires be connected to the terminal marked with the letter "E", earth symbol "⏏", coloured green, or green & yellow.

Grundig Multimedia B.V.

Atrium, Strawinskylaan 3105 • NL-1077 ZX Amsterdam • <http://www.grundig.com>

09/14